

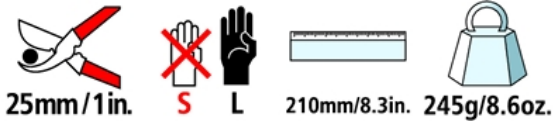

## FELCO 11 - Green

Pruning shear - High performance - Classic, new generation

Made in Switzerland by FELCO



- > **Reliable:** comfortable, light, sturdy handles made of forged aluminium with a lifetime guarantee\* / blade and screw-mounted anvil blade made of high-quality hardened steel / clean, precise cut / all parts can be replaced
- > **Efficient:** easy, durable cutting adjustment / wire cutting notch / sap groove
- > **Ergonomic:** hand protection is provided by the cushion-shock absorber / non-slip coating



## RECOMMENDED FOR

Our recommendation (★ = Recommended, ★★ = Strongly recommended, ★★★ = Best fit)

Viticulture	★★★
Arboriculture	★★★
Horticulture	★★★
Parks and Gardens	★★★
Nursery	★★★
Small hand	★★★
Average-sized hand	★★★
Large hand	★★★
Left-handed	★★★

---

## THE POINTS OF EXCELLENCE



### Wire cutting notch

The blades feature a notch that allows for the cutting of small wires without damaging the cutting edge.



### Sap groove

The sap groove prevents the blade sticking when cutting "sappy" wood. It saves time and makes pruning easier by removing sap and debris after each cut.



### Micrometric adjustment

FELCO's micrometric adjustment system guarantees an optimal adjustment of the cutting head throughout the life of the tool. It ensures a clean and precise cut.



### Shock absorption system

The cushion and shock absorber soften the impact upon finishing cutting. The hand and wrist are also protected.



### Forged aluminum handles

Lightweight, strong and sturdy thanks to special aluminum alloys and advanced precision forging methods. Equipment comes with a lifetime guarantee\*.

## ACCESSORIES



FELCO 902  
Sharpening tool  
Sharpening stone



FELCO 903  
Sharpening tool  
Sharpener



FELCO 910  
Holster  
Leather - With belt loop and clip



FELCO 912  
Holster  
Leather - With belt clip



FELCO 980  
Maintenance product  
Spray







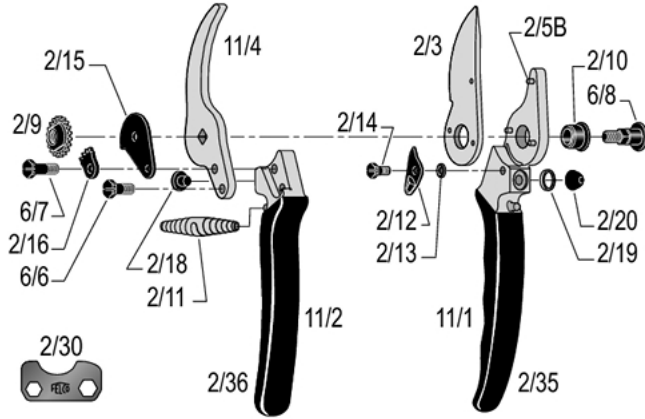































FELCO 990  
Maintenance product  
Grease

**SPARE PARTS**



FELCO	REF.	Designation	Composition	UCC Barcode
	2/30	Adjustment key	1x 2/30	
	2/3	Blade	1x 2/3	
	11/4	Anvil-blade with screw	1x 11/4 + 1x 6/6	
	6/90	Kit	1x 6/7 + 1x 2/16 + 1x 2/9 + 1x 6/8	
	2/91	Kit	2x 2/11	
	2/92	Kit	1x 2/15 + 1x 2/18 + 1x 2/14 + 1x 2/12 + 1x 2/13 + 1x 2/20	
	2/93	Kit	4x 2/18 + 6x 2/20	
	6/94	Kit	1x 2/9 + 1x 6/8	
	11/1	Handle without blade	1x 11/1 + 3x 2/5B + 1x 2/19 + 1x 2/20 + 1x 2/10 + 1x 2/13 + 1x 2/12 + 1x 2/14 + 1x 2/35	

	11/2	Handle without anvil-blade	1x 11/2 + 1x 2/18 + 1x 2/36	 7 83929 40132 4
	2/35	Coating for blade handle	1x 2/35	 7 83929 40164 5
	2/36	Coating for anvil-blade handle	1x 2/36	 7 83929 40165 2
	2/5B	Rivet for blade	1x 2/5B	 7 83929 40166 9
	6/6	Screw for anvil-blade	1x 6/6	 7 83929 40221 5
	6/8	Bolt	1x 6/8	 7 83929 40223 9
	2/9	Nut	1x 2/9	 7 83929 40169 0
	2/10	Bush	1x 2/10	 7 83929 40151 5
	2/11	White spring	1x 2/11	 7 83929 40152 2
	2/12	Thumb catch	1x 2/12	 7 83929 40153 9
	2/13	Spring for thumb catch	1x 2/13	 7 83929 40154 6
	2/14	Screw for thumb catch	1x 2/14	 7 83929 40155 3
	2/15	Catch plate	1x 2/15	 7 83929 40156 0
	2/16	Locking segment	1x 2/16	 7 83929 40157 7
	6/7	Screw for locking segment	1x 6/7	 7 83929 40222 2

	2/18	Cushion	1x 2/18	 7 83929 40159 1
	2/19	Edging	1x 2/19	 7 83929 40160 7
	2/20	Shock absorber	1x 2/20	 7 83929 40162 1

## MAINTENANCE



### Cleaning

It is advisable to clean your tool after each use.  
If your tool is particularly dirty or subject to rusting after exposure to moisture, do not delay cleaning.



### Oiling

After cleaning, it is advisable to oil the tool so as to protect it from corrosion. The oil will also unjam the tool.



### Sharpening

It is advisable to sharpen your tool at least once a day, but if you feel that your tool is not cutting as well as usual, sharpen it right away!



### Dismantling

It is advisable to dismantle your tool on a regular basis, but at the very latest when it appears to be jammed.



## PARTS REPLACEMENT



### Changing the blade

When the blade and the anvil-blade no longer cross, or when the blade is badly damaged, it is advisable to change it.

Regulate the working of the blade and anvil-blade by adjusting the tightening of the nut. The blade should rub against the anvil-blade over 2/3 of its length.



### Changing the anvil-blade

When the blade and anvil-blade no longer cross and the anvil-blade is badly damaged, it is advisable to change it.



### Changing the shock absorber

When the tool closes too abruptly during pruning, and the cushion is in good condition, the shock absorber should be changed.



### Changing the cushion

When the tool closes too abruptly during pruning and the shock absorber is in good condition, the cushion must be changed.



### Changing the thumb catch

When the thumb catch is damaged and loosens when used, even when the screw is readjusted, change it.



**Changing the plastic coatings for handles**

If the coatings are badly damaged, you can replace them.

Soak the coatings for 2 minutes in boiling water - recommended glue: Loctite 415.