

FELCO 31 - Green

Pruning shear - Good performance - Anvil model

Made in Switzerland by FELCO

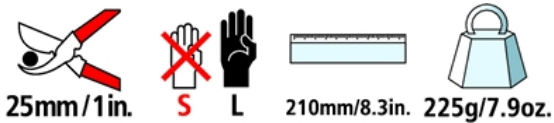

- > **Reliable:** comfortable, light, sturdy handles made of forged aluminium with a lifetime guarantee* / blade made of high-quality hardened steel and screw-mounted adjustable brass anvil / clean, precise cut / all parts can be replaced
- > **Efficient:** easy cutting adjustment
- > **Ergonomic:** hand protection is provided by the ideal shape of the handles / non-slip coating

RECOMMENDED FOR

Our recommendation (★ = Recommended, ★★ = Strongly recommended, ★★★ = Best fit)

Viticulture	★★★
Arboriculture	★★★
Horticulture	★★★
Parks and Gardens	★★★
Nursery	★★★
Small hand	★★★
Medium hand	★★★
Large hand	★★★
Left-handed	★★★

THE POINTS OF EXCELLENCE



Forged aluminum handles

Lightweight, strong and sturdy thanks to special aluminum alloys and advanced precision forging methods. Equipment comes with a lifetime guarantee*.

ACCESSORIES



FELCO 902
Sharpening tool
Sharpening stone



FELCO 903
Sharpening tool
Sharpener



FELCO 910
Holster
Leather - With belt loop and clip



FELCO 912
Holster
Leather - With belt clip



FELCO 980
Maintenance product
Spray







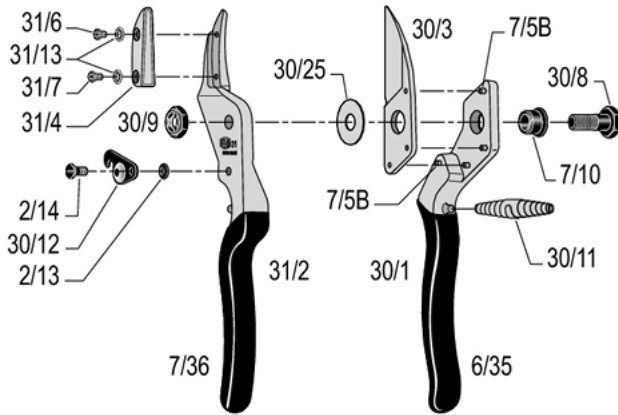

















FELCO 990
Maintenance product
Grease

SPARE PARTS



FELCO	REF.	Designation	Composition	UCC Barcode
	30/3	Blade with washer	1x 30/3 + 1x 30/25	
	31/4	Anvil with screws	1x 31/4 + 1x 31/6 + 1x 31/7 + 2x 31/13	
	30/90	Kit	1x 30/8 + 1x 30/9 + 1x 30/25	
	30/91	Kit	2x 30/11	
	30/92	Kit	1x 2/13 + 1x 30/12 + 1x 2/14	
	30/1	Handle without blade	1x 30/1 + 4x 7/5B + 1x 7/10 + 1x 6/35	
	31/2	Handle without anvil	1x 31/2 + 1x 2/13 + 1x 30/12 + 1x 2/14 + 1x 7/36	
	6/35	Coating for blade handle	1x 6/35	
	7/36	Plastic coating for anvil-blade / anvil handle	1x 7/36	

	7/5B	Rivet for blade	1x 7/5B	 7 83929 40240 6
	30/6	Screw for anvil 4 mm	1x 30/6	 7 83929 40196 6
	30/7	Screw for anvil 6 mm	1x 30/7	 7 83929 40197 3
	30/8	Bolt	1x 30/8	 7 83929 40198 0
	30/9	Nut	1x 30/9	 7 83929 40199 7
	7/10	Bush	1x 7/10	 7 83929 40235 2
	30/25	Washer	1x 30/25	 7 83929 40195 9
	30/11	White spring	1x 30/11	 7 83929 40192 8
	30/12	Thumb catch	1x 30/12	 7 83929 40193 5
	2/13	Spring for thumb catch	1x 2/13	 7 83929 40154 6
	2/14	Screw for thumb catch	1x 2/14	 7 83929 40155 3

MAINTENANCE



Cleaning

It is advisable to clean your tool after each use.

If your tool is particularly dirty or subject to rusting after exposure to moisture, do not delay cleaning.



Oiling

After cleaning, it is advisable to oil the tool so as to protect it from corrosion. The oil will also unjam the tool.



Sharpening

It is advisable to sharpen your tool at least once a day, but if you feel that your tool is not cutting as well as usual, sharpen it right away!



Dismantling

It is advisable to dismantle your tool on a regular basis, but at the very latest when it appears to be jammed.

PARTS REPLACEMENT



Changing the blade

When the blade and the anvil-blade no longer cross, or when the blade is badly damaged, it is advisable to change it.

Regulate the working of the blade and anvil-blade by adjusting the tightening of the nut. The blade should rub against the anvil-blade over 2/3 of its length.



Changing the thumb catch

When the thumb catch is damaged and loosens when used, even when the screw is readjusted, change it.



Changing the plastic coatings for handles

If the coatings are badly damaged, you can replace them.

Soak the coatings for 2 minutes in boiling water - recommended glue: Loctite 415.